

アルミC型ジョイナー

■アルミC型ジョイナー 2.73m (B2アルマイト仕上げ)

2.5CS (2.73m)

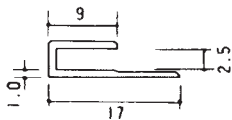

3.5CS (2.73m)

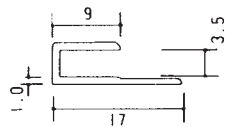

4.5CS (2.73m)

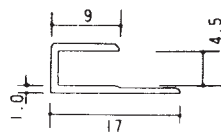

5.5CS (2.73m)

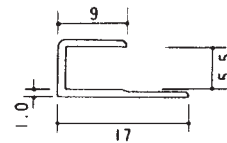

6.5CS (2.73m)

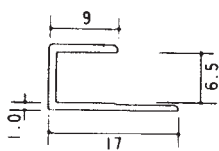

7.5CS (2.73m)

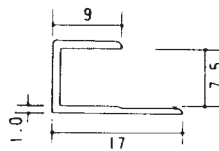

8.5CS (2.73m)

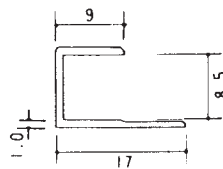

10CS (2.73m)

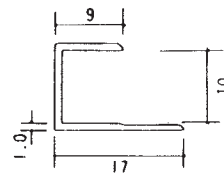

10.5CS (2.73m)

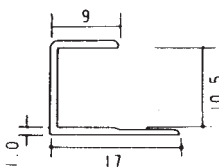

13CS (2.73m)

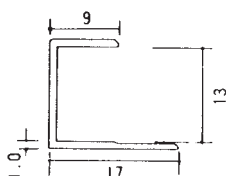

■断熱材用アルミジョイナー (B2アルマイト仕上げ)

アルミKK25 (3m)

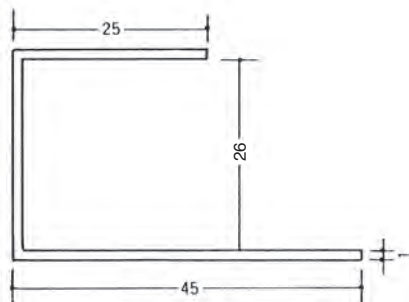

アルミKK50 (3m)

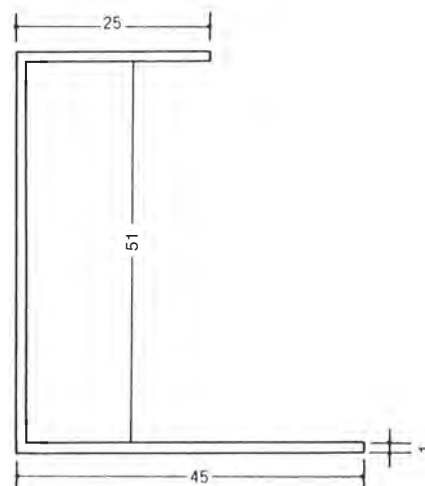

アルミH型ジョイナー

■アルミH型ジョイナー 2.73m (B2アルマイト仕上げ)

2.5HS (2.73m)

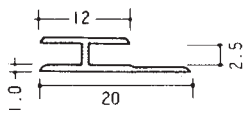

3.5HS (2.73m)

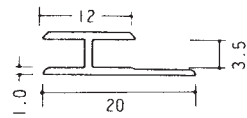

4.5HS (2.73m)

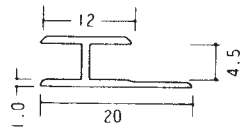

5.5HS (2.73m)

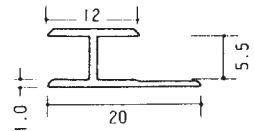

6.5HS (2.73m)

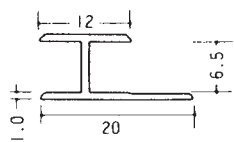

7.5HS (2.73m)

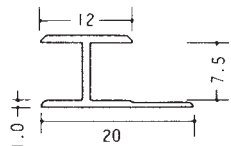

8.5HS (2.73m)

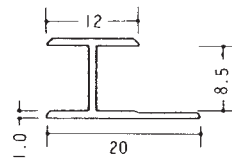

10HS (2.73m)

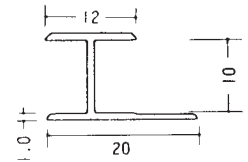

10.5HS (2.73m)

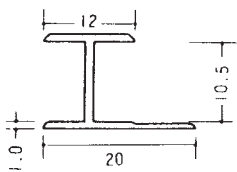

13HS (2.73m)

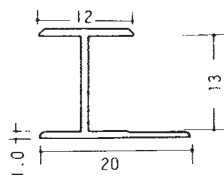

■断熱材用アルミジョイナー (B2アルマイト仕上げ)

アルミ25KHS (2.73m)

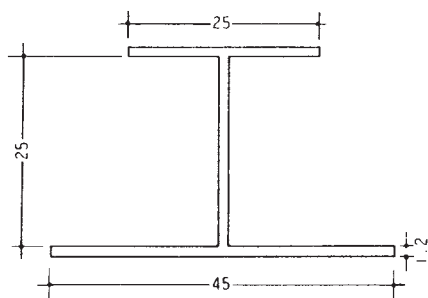

アルミ50KHS (2.73m)

